

## Product Summary

BV <sub>DSS</sub>	Max R <sub>DS(ON)</sub>	Max I <sub>D</sub> @ T <sub>A</sub> = +25°C
-30V	1Ω @ V <sub>GS</sub> = -4.5V	-0.76A
	1.5Ω @ V <sub>GS</sub> = -2.5V	-0.62A
	2Ω @ V <sub>GS</sub> = -1.8V	-0.54A

## Description and Applications

This MOSFET has been designed to minimize the on-state resistance (R<sub>DS(ON)</sub>) and yet maintain superior switching performance, making it ideal for high efficiency power management applications.

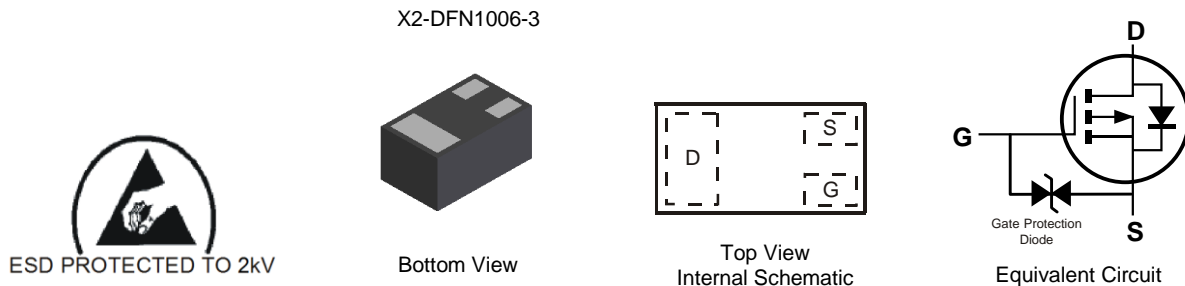
- Load Switch in portable electronics

## Features and Benefits

- Footprint of just 0.6mm<sup>2</sup> – Thirteen Times Smaller than SOT23
- 0.4mm Profile – Ideal for Low Profile Applications
- Low Gate Threshold Voltage
- Fast Switching Speed
- ESD Protected Gate 2KV
- Totally Lead-Free & Fully RoHS Compliant (Notes 1 & 2)**
- Halogen and Antimony Free. "Green" Device (Note 3)**
- Qualified to AEC-Q101 Standards for High Reliability**

## Mechanical Data

- Case: X2-DFN1006-3
- Case Material: Molded Plastic, "Green" Molding Compound. UL Flammability Classification Rating 94V-0
- Moisture Sensitivity: Level 1 per J-STD-020
- Terminals: Finish — NiPdAu over Copper Leadframe; Solderable per MIL-STD-202, Method 208 **(e4)**
- Terminal Connections: See Diagram
- Weight: 0.001 grams (Approximate)



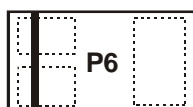
## Ordering Information (Note 4)

Part Number	Marking	Reel Size (inches)	Tape Width (mm)	Quantity per Reel
DMP31D0UFB4-7B	P6	7	8	10,000

- Notes:
- No purposely added lead. Fully EU Directive 2002/95/EC (RoHS) & 2011/65/EU (RoHS 2) compliant.
  - See [http://www.diodes.com/quality/lead\\_free.html](http://www.diodes.com/quality/lead_free.html) for more information about Diodes Incorporated's definitions of Halogen- and Antimony-free, "Green" and Lead-free.
  - Halogen- and Antimony-free "Green" products are defined as those which contain <900ppm bromine, <900ppm chlorine (<1500ppm total Br + Cl) and <1000ppm antimony compounds.
  - For packaging details, go to our website at <http://www.diodes.com/products/packages.html>.

## Marking Information

DMP31D0UFB4-7B



P6 = Product Type Marking Code

Top View  
Bar Denotes Gate  
And Source Side

**Maximum Ratings** (@T<sub>A</sub> = +25°C, unless otherwise specified.)

Characteristic			Symbol	Value	Unit
Drain-Source Voltage			V <sub>DSS</sub>	-30	V
Gate-Source Voltage			V <sub>GSS</sub>	±8	V
Continuous Drain Current	Steady State	T <sub>A</sub> = +25°C (Note 6)	I <sub>D</sub>	-0.76	A
		T <sub>A</sub> = +85°C (Note 6)		-0.55	
		T <sub>A</sub> = +25°C (Note 5)		-0.54	
Pulsed Drain Current (Note 7)			I <sub>DM</sub>	2	A

**Thermal Characteristics** (@T<sub>A</sub> = +25°C, unless otherwise specified.)

Characteristic		Symbol	Value	Unit
Power Dissipation	(Note 5)	P <sub>D</sub>	0.46	W
	(Note 6)		0.92	
	(Note 5)		271	
Thermal Resistance, Junction to Ambient	(Note 5)	R <sub>θJA</sub>	271	°C/W
	(Note 6)		136	
Operating and Storage Temperature Range		T <sub>J</sub> , T <sub>STG</sub>	-55 to +150	°C

- Notes:
- Device mounted on FR-4 substrate PC board, 2oz copper, with minimum recommended pad layout.
  - Device mounted on FR-4 substrate PC board, 2oz copper, with thermal vias to bottom layer 1 inch square copper plate.
  - Device mounted on minimum recommended pad layout test board, 10μs pulse duty cycle = 1%.

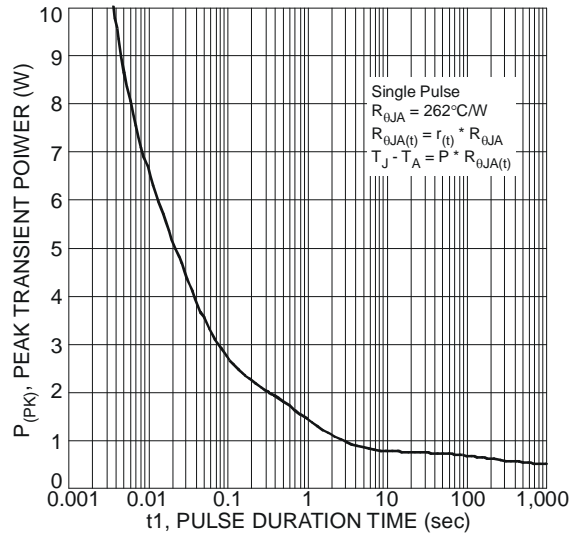


Fig. 1 Single Pulse Maximum Power Dissipation

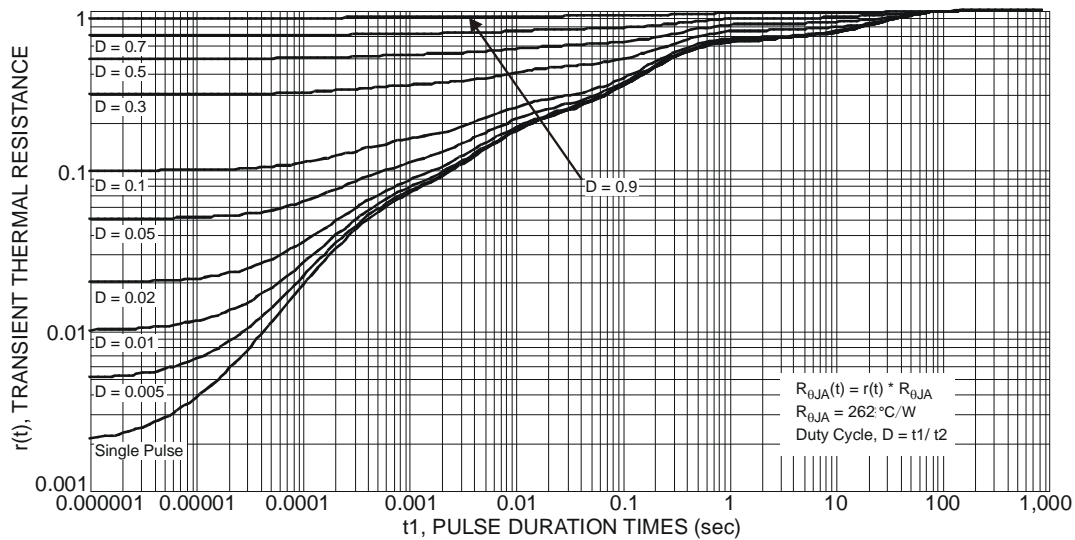


Fig. 2 Transient Thermal Resistance

**Electrical Characteristics** (@ $T_A = +25^\circ\text{C}$ , unless otherwise specified.)

Characteristic	Symbol	Min	Typ	Max	Unit	Test Condition
<b>OFF CHARACTERISTICS (Note 8)</b>						
Drain-Source Breakdown Voltage	$BV_{DSS}$	-30	-	-	V	$V_{GS} = 0V, I_D = -250\mu A$
Zero Gate Voltage Drain Current $T_J = +25^\circ\text{C}$	$I_{DSS}$	-	-	-1	$\mu A$	$V_{DS} = -30V, V_{GS} = 0V$
Gate-Source Leakage	$I_{GSS}$	-	-	$\pm 3$	$\mu A$	$V_{GS} = \pm 8V, V_{DS} = 0V$
<b>ON CHARACTERISTICS (Note 8)</b>						
Gate Threshold Voltage	$V_{GS(TH)}$	-0.5	-0.6	-1.1	V	$V_{DS} = V_{GS}, I_D = -250\mu A$
Static Drain-Source On-Resistance	$R_{DS(ON)}$	-	0.45	1	$\Omega$	$V_{GS} = -4.5V, I_D = -400mA$
			0.54	1.5		$V_{GS} = -2.5V, I_D = -200mA$
			0.64	2		$V_{GS} = -1.8V, I_D = -100mA$
Forward Transfer Admittance	$ Y_{fs} $	50	-	-	mS	$V_{DS} = -3V, I_D = -300mA$
Diode Forward Voltage	$V_{SD}$	-	-	-1.2	V	$V_{GS} = 0V, I_S = -300mA$
<b>DYNAMIC CHARACTERISTICS (Note9)</b>						
Input Capacitance	$C_{iss}$	-	76	150	pF	$V_{DS} = -15V, V_{GS} = 0V,$ $f = 1.0MHz$
Output Capacitance	$C_{oss}$	-	9	20	pF	
Reverse Transfer Capacitance	$C_{rss}$	-	6.43	15	pF	
Gate Resistance	$R_g$	-	167	-	$\Omega$	$V_{DS} = 0V, V_{GS} = 0V, f = 1MHz$
Total Gate Charge	$Q_g$	-	0.9	-	nC	$V_{GS} = -4.5V, V_{DS} = -15V, I_D = -1A$
Total Gate Charge	$Q_g$	-	1.5	-	nC	$V_{GS} = -8V, V_{DS} = -15V,$ $I_D = -1A$
Gate-Source Charge	$Q_{gs}$	-	0.1	-	nC	
Gate-Drain Charge	$Q_{gd}$	-	0.2	-	nC	
Turn-On Delay Time	$t_{D(ON)}$	-	4.98	-	ns	$V_{DD} = -10V, R_L = 10\Omega$ $V_{GS} = -4.5V, R_g = 6\Omega$
Turn-On Rise Time	$t_R$	-	5.85	-	ns	
Turn-Off Delay Time	$t_{D(OFF)}$	-	35.7	-	ns	
Turn-Off Fall Time	$t_F$	-	16.6	-	ns	

Notes: 8. Short duration pulse test used to minimize self-heating effect.  
9. Guaranteed by design. Not subject to product testing.

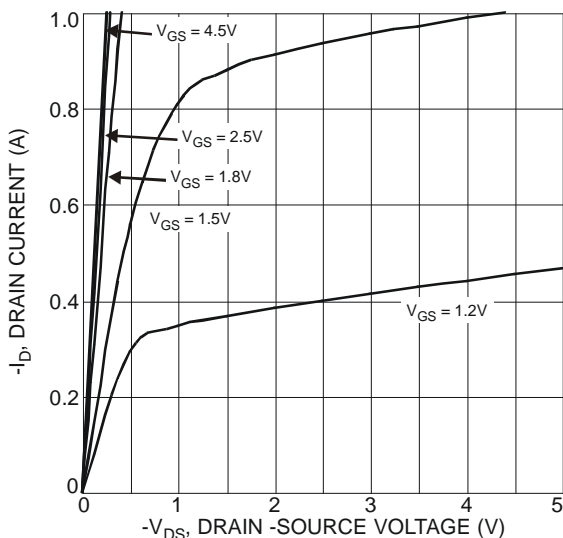
**Typical Electrical Characteristics**


Fig. 3 Typical Output Characteristics

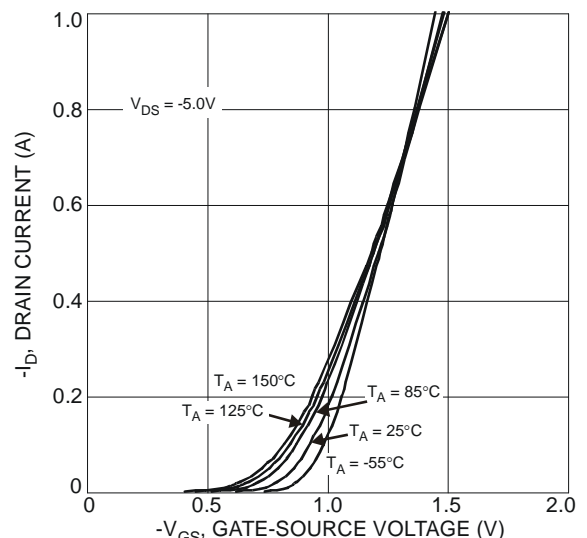


Fig. 4 Typical Transfer Characteristics

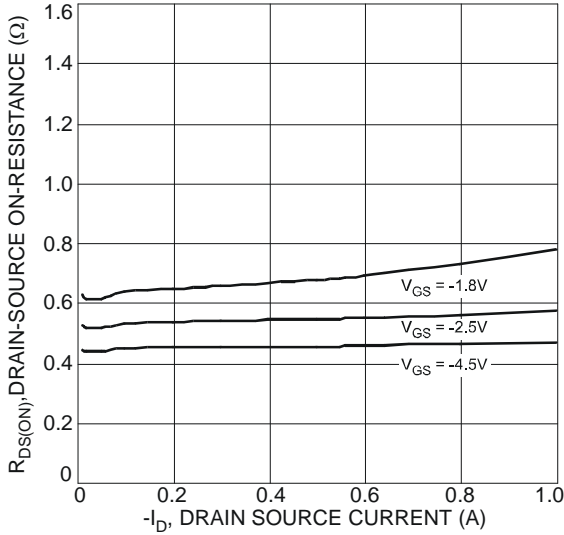


Fig. 5 Typical On-Resistance vs. Drain Current and Gate Voltage

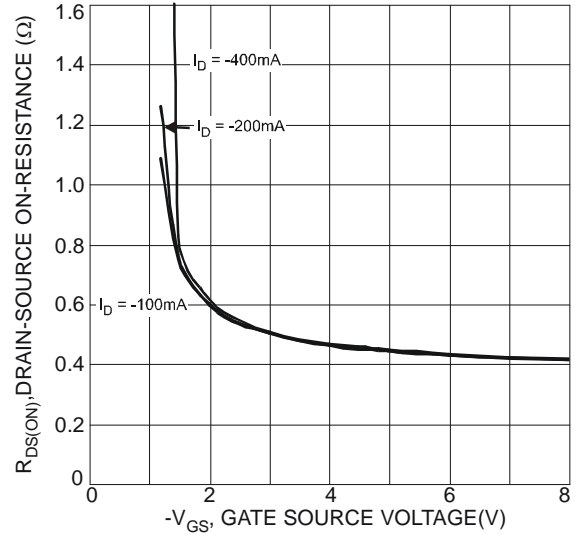


Fig. 6 Typical On-Resistance vs. Drain Current and Gate Voltage

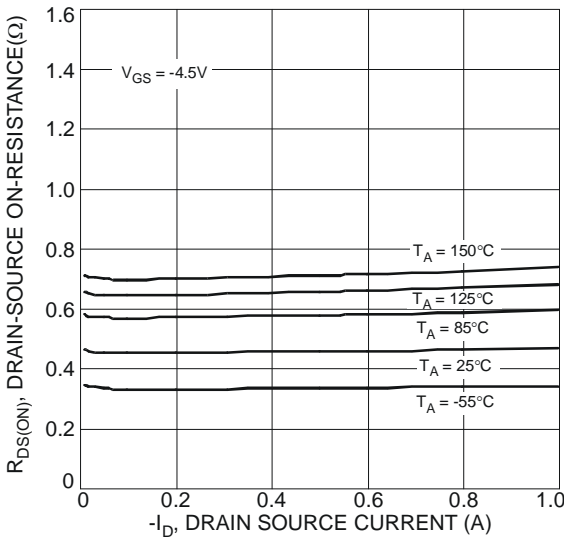


Fig. 7 Typical On-Resistance vs. Drain Current and Temperature

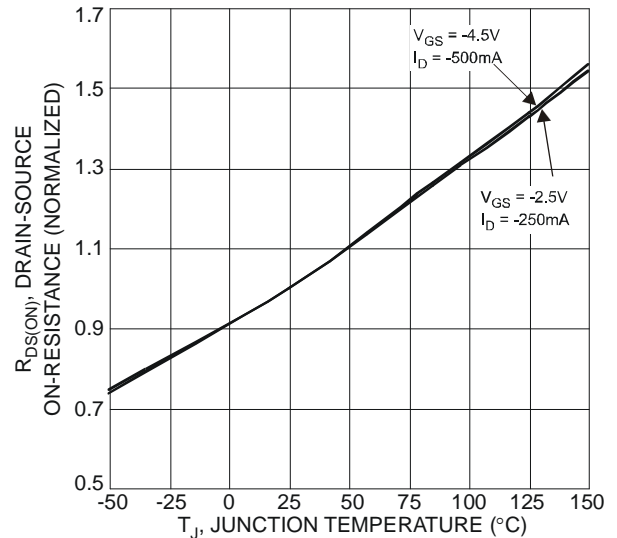


Fig. 8 On-Resistance Variation with Temperature

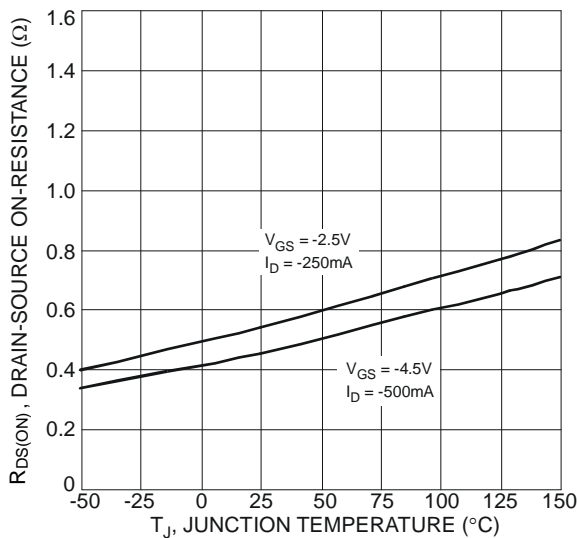


Fig. 9 On-Resistance Variation with Temperature

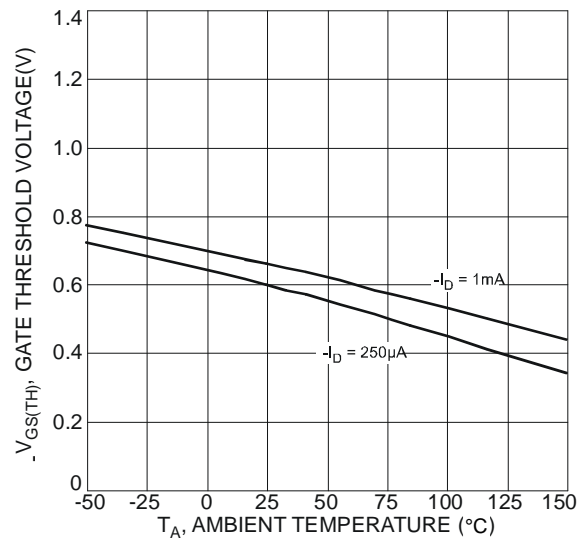


Fig. 10 Gate Threshold Variation vs. Ambient Temperature

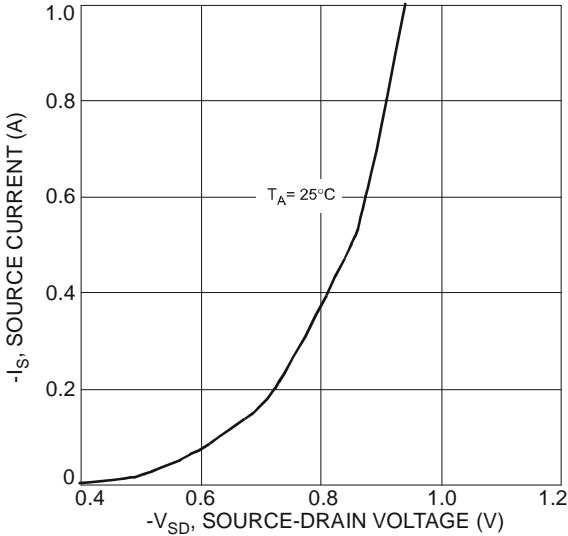


Fig. 11 Diode Forward Voltage vs. Current

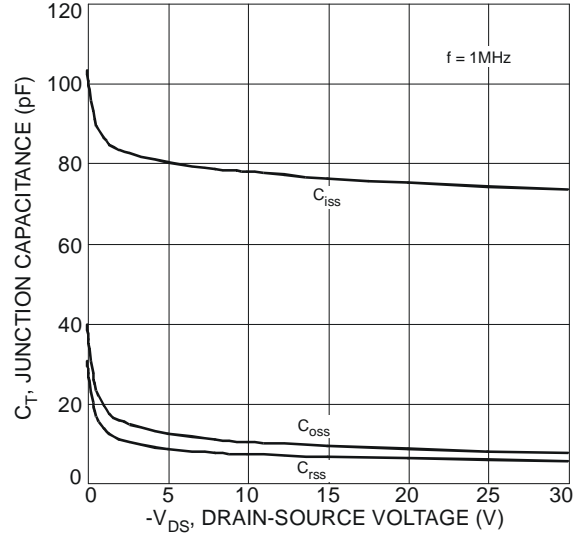


Fig. 12 Typical Junction Capacitance

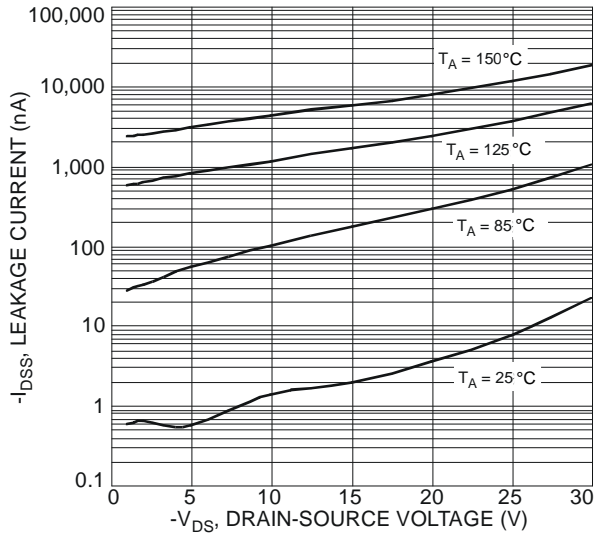


Fig. 13 Typical Drain-Source Leakage Current vs. Voltage

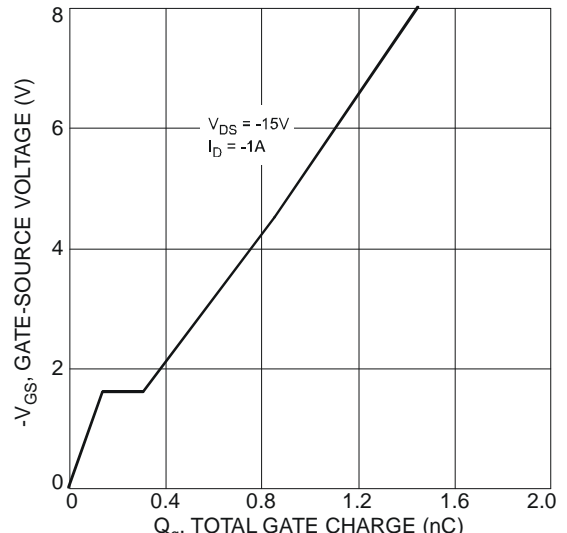
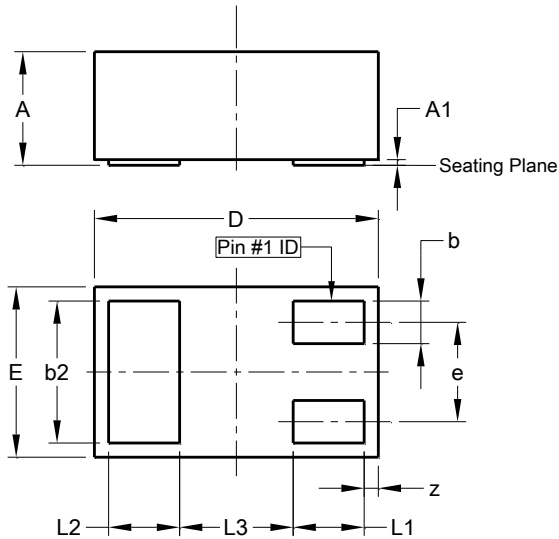


Fig. 14 Gate-Charge Characteristics

## Package Outline Dimensions

Please see <http://www.diodes.com/package-outlines.html> for the latest version.

**X2-DFN1006-3**

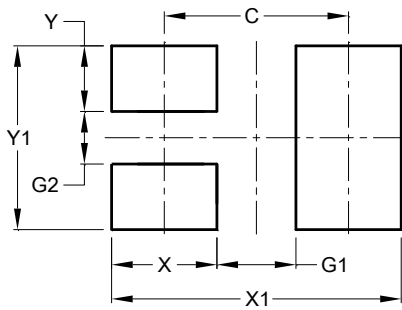


X2-DFN1006-3			
Dim	Min	Max	Typ
A		0.40	
A1	0.00	0.05	0.03
b	0.10	0.20	0.15
b2	0.45	0.55	0.50
D	0.95	1.05	1.00
E	0.55	0.65	0.60
e	-	-	0.35
L1	0.20	0.30	0.25
L2	0.20	0.30	0.25
L3	-	-	0.40
z	0.02	0.08	0.05
<b>All Dimensions in mm</b>			

## Suggested Pad Layout

Please see <http://www.diodes.com/package-outlines.html> for the latest version.

**X2-DFN1006-3**



Dimensions	Value (in mm)
C	0.70
G1	0.30
G2	0.20
X	0.40
X1	1.10
Y	0.25
Y1	0.70

**IMPORTANT NOTICE**

DIODES INCORPORATED MAKES NO WARRANTY OF ANY KIND, EXPRESS OR IMPLIED, WITH REGARDS TO THIS DOCUMENT, INCLUDING, BUT NOT LIMITED TO, THE IMPLIED WARRANTIES OF MERCHANTABILITY AND FITNESS FOR A PARTICULAR PURPOSE (AND THEIR EQUIVALENTS UNDER THE LAWS OF ANY JURISDICTION).

Diodes Incorporated and its subsidiaries reserve the right to make modifications, enhancements, improvements, corrections or other changes without further notice to this document and any product described herein. Diodes Incorporated does not assume any liability arising out of the application or use of this document or any product described herein; neither does Diodes Incorporated convey any license under its patent or trademark rights, nor the rights of others. Any Customer or user of this document or products described herein in such applications shall assume all risks of such use and will agree to hold Diodes Incorporated and all the companies whose products are represented on Diodes Incorporated website, harmless against all damages.

Diodes Incorporated does not warrant or accept any liability whatsoever in respect of any products purchased through unauthorized sales channel. Should Customers purchase or use Diodes Incorporated products for any unintended or unauthorized application, Customers shall indemnify and hold Diodes Incorporated and its representatives harmless against all claims, damages, expenses, and attorney fees arising out of, directly or indirectly, any claim of personal injury or death associated with such unintended or unauthorized application.

Products described herein may be covered by one or more United States, international or foreign patents pending. Product names and markings noted herein may also be covered by one or more United States, international or foreign trademarks.

This document is written in English but may be translated into multiple languages for reference. Only the English version of this document is the final and determinative format released by Diodes Incorporated.

**LIFE SUPPORT**

Diodes Incorporated products are specifically not authorized for use as critical components in life support devices or systems without the express written approval of the Chief Executive Officer of Diodes Incorporated. As used herein:

A. Life support devices or systems are devices or systems which:

1. are intended to implant into the body, or
2. support or sustain life and whose failure to perform when properly used in accordance with instructions for use provided in the labeling can be reasonably expected to result in significant injury to the user.

B. A critical component is any component in a life support device or system whose failure to perform can be reasonably expected to cause the failure of the life support device or to affect its safety or effectiveness.

Customers represent that they have all necessary expertise in the safety and regulatory ramifications of their life support devices or systems, and acknowledge and agree that they are solely responsible for all legal, regulatory and safety-related requirements concerning their products and any use of Diodes Incorporated products in such safety-critical, life support devices or systems, notwithstanding any devices- or systems-related information or support that may be provided by Diodes Incorporated. Further, Customers must fully indemnify Diodes Incorporated and its representatives against any damages arising out of the use of Diodes Incorporated products in such safety-critical, life support devices or systems.

Copyright © 2016, Diodes Incorporated

[www.diodes.com](http://www.diodes.com)